

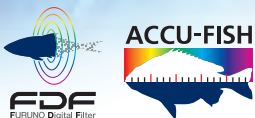

FURUNO

COLOR LCD SOUNDER

Model **FCV-1150**

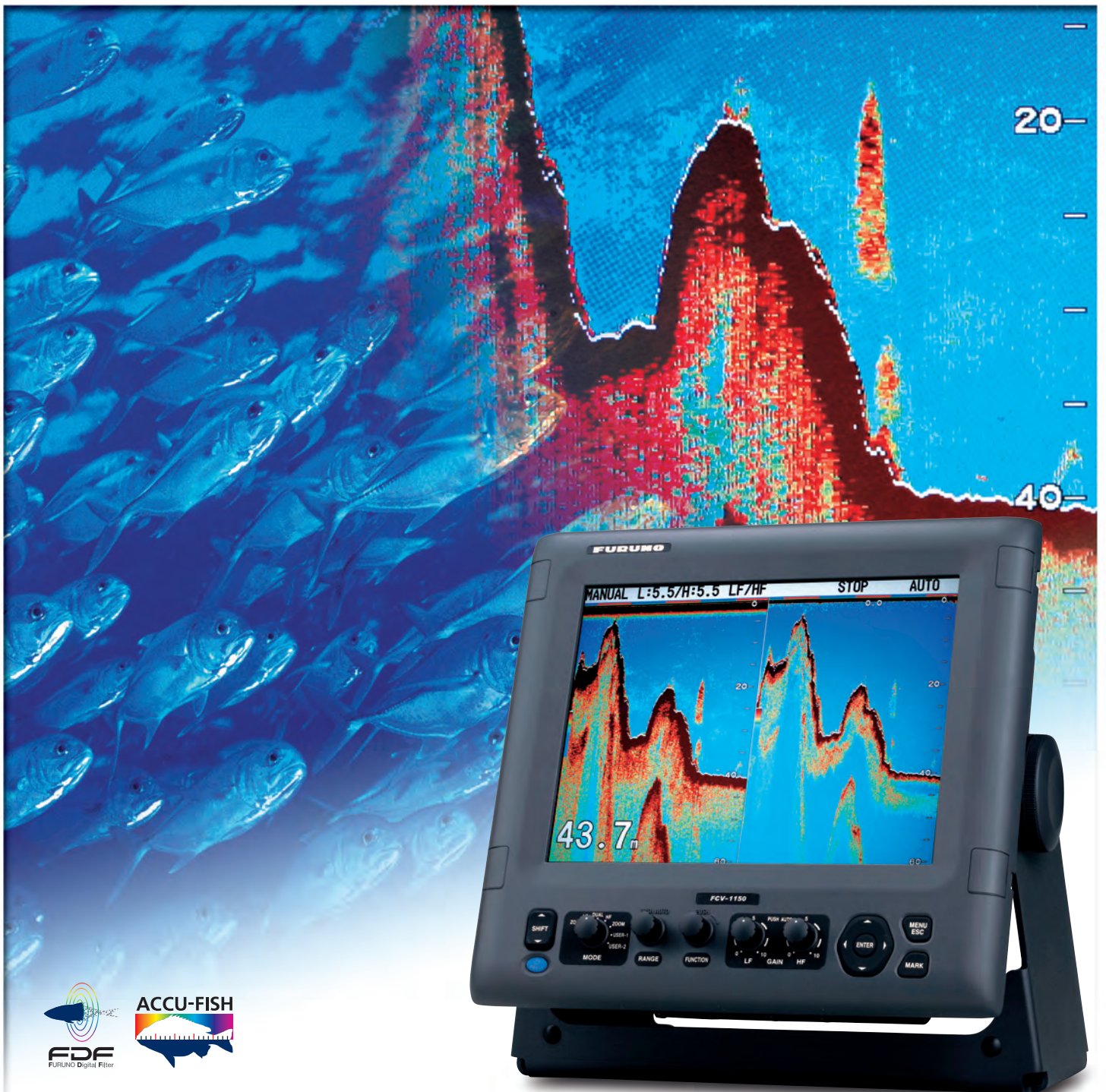

www.furuno.com

High performance 12.1" LCD digital fish find

The FCV-1150 is a color digital sounder designed for a variety of professional fishing operations. It features a high-brightness, bonded 12.1" LCD display with AR-coated glass filter and anti-polarized sunglass filter, providing superior viewing even in direct sunlight. You can choose to display the echo presentation in 8, 16, or 64 colors, with color assignment dependent on the strength of the returned echo. The FURUNO Free Synthesizer (FFS) Transceiver allows for a wide selection of operating

frequencies. You may choose any two frequencies between 28 and 200 kHz to best suit your fishing operation. Output power is selectable from 1, 2 or 3 kW. A wide variety of display modes and functions are available that provide skippers with simple and intuitive information. The FCV-1150 can also be connected to a FURUNO satellite compass to compensate for heaving, thus providing unwavering, stable detection even in rough seas.

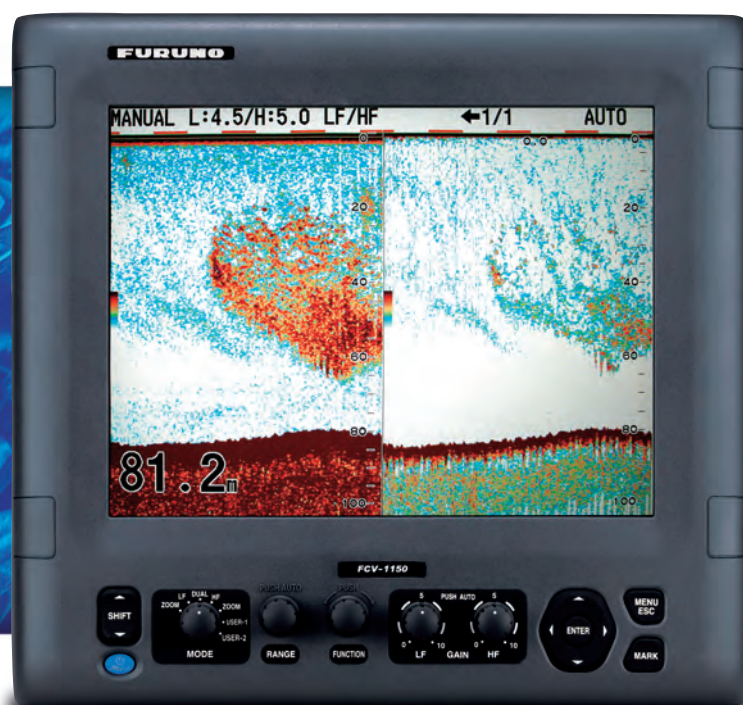

COLOR LCD SOUNDER

Model **FCV-1150**

- ▶ *Post-processing gain control applies changes to gain setting to all existing returns on the display*
- ▶ *Available Heaving Compensation provides stable echo presentation even in rough seas (Satellite Compass required)*
- ▶ *FURUNO Digital Filter (FDF) delivers crystal clear target presentation*
- ▶ *FURUNO Free Synthesizer (FFS) allows for adjustable operating frequency*
- ▶ *Unique fish size analyzing function ACCU-FISH™ mode (available with 50/200-1T transducer)*
- ▶ *White Edge bottom discrimination*

er delivers super clear view of fish targets!

Quick Gain Setting

With conventional gain controls, changes are made for new echoes only when a change in the setting is applied. With the FCV-1150's Quick Gain control, changes in the Gain setting are applied to new echoes as well as all of the echoes already on the screen. Because the changes are applied to both new and existing returns, you will be able to quickly and easily find the right Gain setting for your conditions.

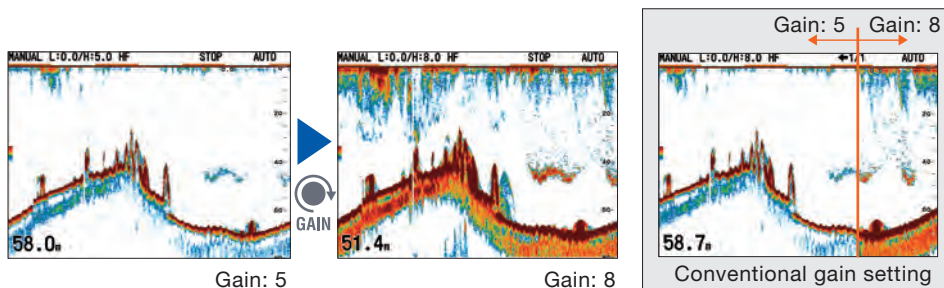

Faster TX Rate For Detailed Detection

The rate of transmission is increased by more than 30% compared to current conventional fish finders. As a result, more detailed information about underwater conditions can be gained through the same sounding interval. This means that the transmission speed is raised in shallow waters, and lowered in deep waters. The high-speed transmission provides for detailed detection of seabed targets.

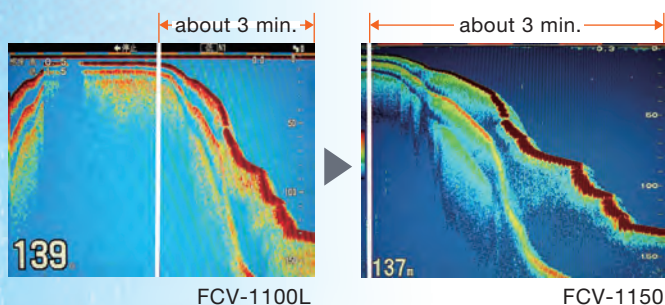

Heaving Compensation

Even in rough sea conditions, the FCV-1150 compensates for heaving, presenting a display without undulations caused by the sea conditions. FURUNO Satellite Compass SC-30, SC-50 or SC-110 required.

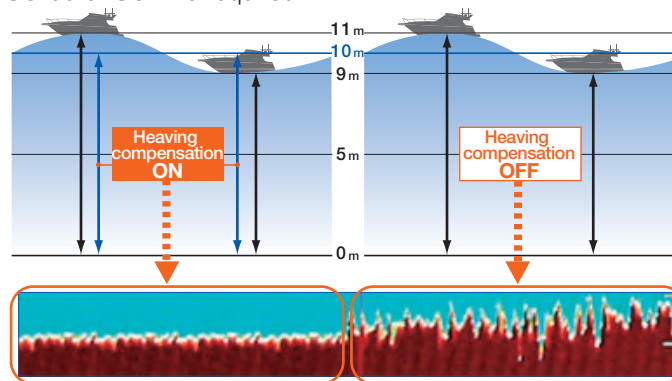

Function Key

An often-used function such as TVG (Time Varied Gain) can be programmed to register with the press of the Function key. This will give you access to any menu item without opening the menu.



Functions which can be registered

Pic. Advance / Interference / Color Erase / Clutter / White Line / White Marker / TVG / STC / Bottom Zone / A-Scope / Split Range / Auto Shift / Freq Choice / Freq Control

Operating Frequency Adjustment

If a FURUNO transducer is used, the operating frequency is automatically set in the menu. The user can shift the operating frequency at any time from the menu. With the FURUNO 82B-35R transducer, the operator can select any operating frequency from 65 to 110 kHz. This feature is particularly useful for vessels targeting many different species, or when the fish finders of other ships in the area cause interference.

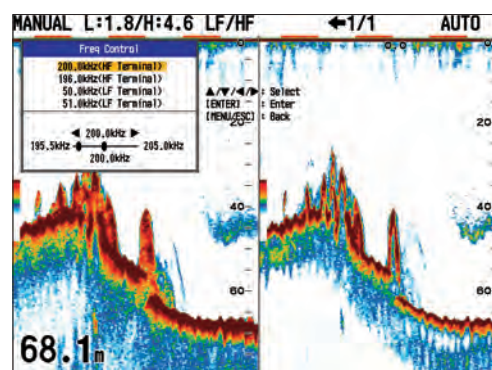

ACCU-FISH™ identifies individual fish with size and fish mark function

Recognizes individual or multiple fish instantaneously

ACCU-FISH™ is a fish size assessment function of FCV-1150 that is unique to FURUNO. In order to assess individual fish size, echo returns are evaluated based on strength and turned into fish size display on screen. ACCU-FISH™ can detect fish size from 10 to 199 cm, in depths of 2 to 100 m.

In some instances, fish size indicated on FCV-1150 may differ from actual size. Please read the operator's manual carefully before using this feature.

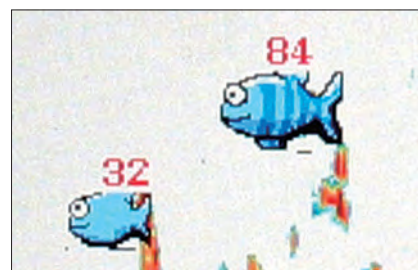

COLOR LCD SOUNDER

Model **FCV-1150**

SPECIFICATIONS OF FCV-1150

GENERAL

1. Operating Frequencies

The synthesized transceiver works with dual frequencies in 28 to 200 kHz. Specify transducer type when ordering, among 28/38/50/68/82/88/107/150/200 kHz

2. Output Power

1/2/3 kW

3. Power Reduction

Auto/10 to 100 % (in 10 % step)

4. Tx Rate

5 to 3000/min

5. Pulselength

Short1/Short2/Standard/Long/Manual (Manual Pulse length: 0.05 to 5.0 ms)

6. RX Band

Narrow/Standard/Wide

7. Amplifier

High dynamic range

DISPLAY

1. Display

12.1" color LCD (SVGA: 800 x 600)

2. Color

8/16/64

3. Ranges

5 to 3000 m (Split Range available)

4. Shift

0 to 2000 m

5. Marker Zoom/Bottom-lock Expansion Ranges

5 to 2000 m

6. Display mode

Single (HF/LF), Dual, Single + Zoom, two Custom Modes

Zoom Mode (Bottom Lock, Bottom Zoom, Marker Zoom), Mix Mode, Nav data, A-scope

7. Picture Advance Direction

Left, Right, L/R

8. Picture Advance Speed

Stop, 1/16, 1/8, 1/4, 1/2, 1/1, 2/1, 4/1, Synchronized with own ship speed

9. Alarms

Audio-visual alarms for a preset value of depth, fish and water temperature

10. Language

English, French, Spanish, German, Italian, Portuguese, Swedish, Danish, Norwegian, Finish, Greek, Chinese, Japanese, Thai, Korean, Russian

11. Others

Auto Mode, Interference, Clutter, TVG, Color Erase, Hue, Temp Graph, A-scope, White Marker Heaving compensation

Added Function

Heaving compensation

DATA INTERFACE

NMEA0183 (Ver. 1.5, 2.0 or 3.0; Any talker)

Input: BWC, GGA, GLC, GLL, GNS, GTD, HDG, HDT, MDA, MTW, MWV, RMA, RMB, RMC, VHW, VTG, XTE

Output: DBT, DBS, DPT, MTW*, TLL, VHW, RMB, SDmrk, dat *Optional sensor required

Other: LAN

ENVIRONMENTAL CONDITIONS

Display Unit: -15 °C to +55 °C (IEC60945 tested)

Water Resistance: IP55 (When flush mounted)

POWER SUPPLY

12-24 VDC: 3.3-1.7 A. 100/110/220/230 VAC with optional rectifier

EQUIPMENT LIST

Standard

1. Display Unit
2. Installation Materials and Standard Spare Parts

Option

1. Speed/temperature sensor
ST950 (Thru-hull, bronze/plastic)
2. Temperature sensor
T42 (Thru-hull, bronze), T80 (Transom, stainless steel)
3. NMEA cable
MJ-A6SPF0003-050C (5 m)
CO-SPEVV-SB-C 2P x 0.2SQLF (5/10/15 m)
4. Rectifier
PR-62
5. Transducer (Specify the frequency and type of transducer)
 - 1 kW: 28F-8 (28 kHz), 50B-6/6B (50 kHz), 50B-9B (50 kHz), 68F-8H (68 kHz), 88B-8 (88 kHz), 200B-5S (200 kHz), 50/200-1T (50/200 kHz), 50/200-12M (50/200 kHz)
 - 2 kW: 28F-18 (28 kHz), 28BL-6HR (28 kHz), 38BL-9HR (38 kHz), 50B-12 (50 kHz), 50BL-12/12HR (50 kHz), 82B-35R (82 kHz), 88B-10 (88 kHz), 200B-8/8B (200 kHz)
 - 3 kW: 28F-24H (28 kHz), 28BL-12HR (28 kHz), 38BL-15HR (38 kHz), 50F-24H (50 kHz), 50BL-24H/24HR (50 kHz), 68F-30H (68 kHz), 88F-126H (88 kHz), 100B-10R (100 kHz), 150B-12H (150 kHz), 200B-12H (200 kHz)

DISPLAY UNIT FCV-1150

8.2 kg 18.1 lb

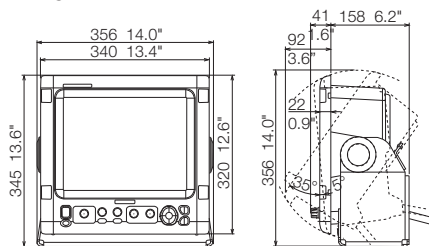

Flush mount

6.8 kg 15.0 lb

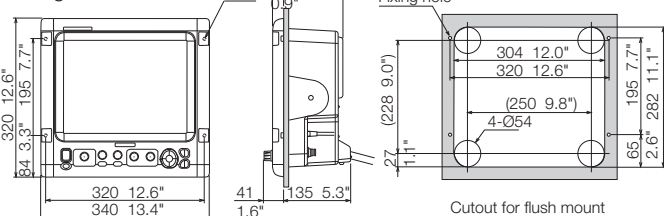

INTERCONNECTION DIAGRAM

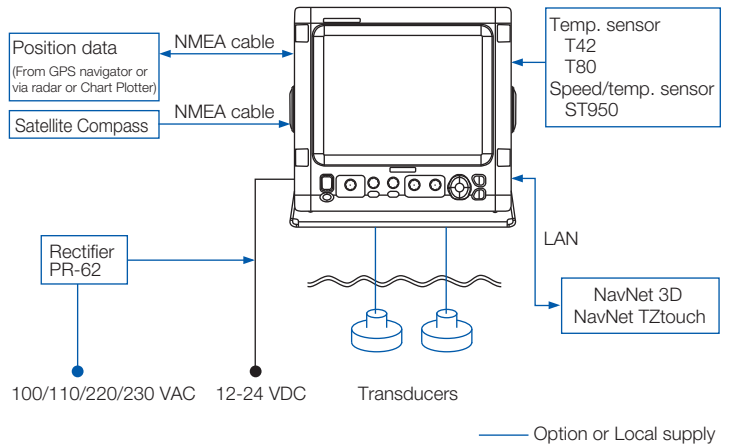

Beware of similar products

All brand and product names are registered trademarks, trademarks or service marks of their respective holders.

SPECIFICATIONS SUBJECT TO CHANGE WITHOUT NOTICE

FURUNO ELECTRIC CO., LTD.
Japan | www.furuno.com

FURUNO U.S.A., INC.
U.S.A. | www.furunousa.com

FURUNO PANAMA S.A.
Republic of Panama | www.furuno.com.pa

FURUNO (UK) LIMITED
U.K. | www.furuno.co.uk

FURUNO NORGE A/S
Norway | www.furuno.no

FURUNO DANMARK A/S
Denmark | www.furuno.dk

FURUNO SVERIGE AB
Sweden | www.furuno.se

FURUNO FINLAND OY
Finland | www.furuno.fi

FURUNO POLSKA Sp. z o.o.
Poland | www.furuno.pl

FURUNO DEUTSCHLAND GmbH
Germany | www.furuno.de

FURUNO FRANCE S.A.S.
France | www.furuno.fr

FURUNO ESPAÑA S.A.
Spain | www.furuno.es

FURUNO ITALIA S.R.L.
Italy | www.furuno.it

FURUNO HELLAS S.A.
Greece | www.furuno.gr

FURUNO (CYPRUS) LTD
Cyprus | www.furuno.com.cy

FURUNO SHANGHAI CO., LTD.
China | www.furuno.com/cn

FURUNO CHINA CO., LTD.
Hong Kong | www.furuno.com/cn

FURUNO SINGAPORE
Singapore | www.furuno.sg

PT FURUNO ELECTRIC INDONESIA
Indonesia | www.furuno.id

FURUNO ELECTRIC (MALAYSIA) SND. BHD.
Malaysia | www.furuno.my

G-2302LB

Catalogue No. CA000002008