

FURUNO

RADAR

Model: FAR-22x8 series

Keep Steady At Sea

with the safe, reliable and user-friendly next generation Radar



www.furuno.com

Keep Steady At Sea

with the safe, reliable and user-friendly next generation Radar



RADAR

FAR-22x8 series

for Category 2 of ship/craft, with 19" LCD

FAR-2218/FAR-2218-BB

X-band, 12 kW, TR up

FAR-2228/FAR-2228-BB

X-band, 25 kW, TR up

FAR-2228-NXT/FAR-2228-NXT-BB

X-band, 600 W, TR up, Solid State

FAR-2238S/FAR-2238S-BB

S-band, 30 kW, TR up,

FAR-2238S-NXT/FAR-2238S-NXT-BB S-band, 250 W, TR up, Solid State

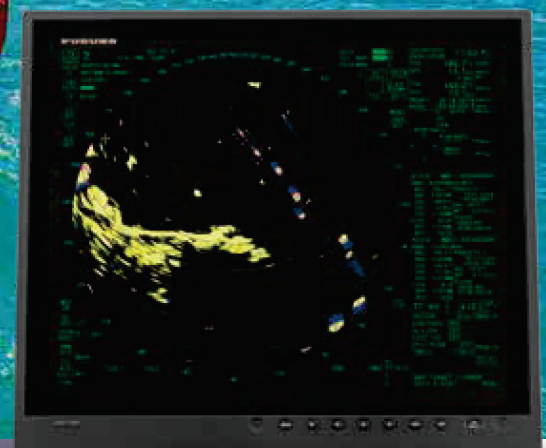

Complies with the following regulations:

| | |
|------------------|--------------------|
| IEC 62388 Ed.2.0 | IEC 61162-1 Ed.5.0 |
| IEC 62288 Ed.2.0 | IEC 60945 Ed.4.0 |
| IEC 61162-2 | IEC 61162-450 |

Advanced technologies for navigation safety

The Furuno FAR-22x8 series is a brand-new Radar series characterized by its state-of-the-art antenna design and innovative signal processing technologies.

Furuno's latest, advanced technologies and intuitive design will increase situational awareness, facilitating unparalleled navigational safety.

► Automatic Clutter Elimination (ACE) for unprecedented echo clarity

Quickly adjusts the Radar image with a single button press. When the ACE function is activated, the system automatically optimizes clutter reduction filters and gain control according to the sea and weather conditions.

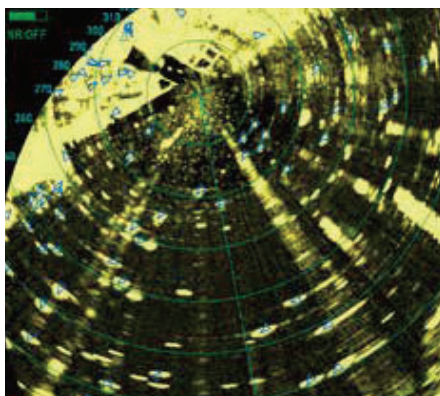

ACE OFF

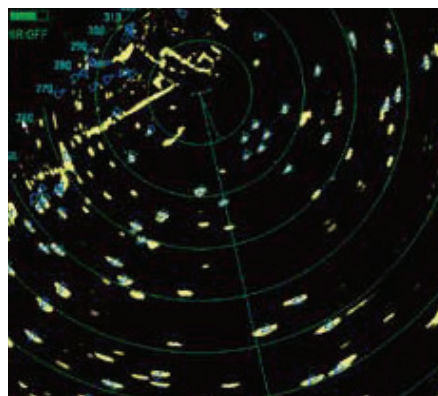

ACE ON

► Fast Target Tracking™ function provides early-stage collision avoidance

With Fast Target Tracking™, the FAR-22x8 series provides accurate tracking information; speed and course vectors are displayed in mere seconds allowing operators to take action and avoid incidents at a very early stage.

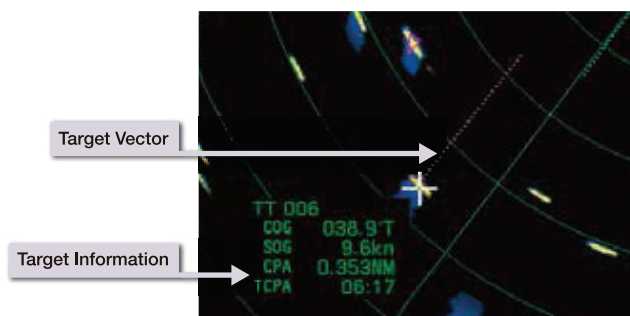

Solid State Radar model - NXT - specializes in target detection and maintainability

Compared to the traditional Magnetron Radar, the Solid State Radar NXT Series provides highly reliable target detection while requiring low power.

► Clear images

Furuno Solid State Radar technology generates clear echo images, which allows users to obtain a clear picture of the area around their vessel, including weaker echoes from small crafts.

► Reducing the time and cost for maintenance

- No need to replace the magnetron
- Removal of the consumable parts thanks to a fan-less antenna (S-band only)

Power Amplifier Module of the Solid State transceiver

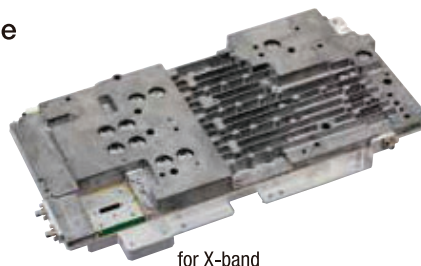



Exceptionally intuitive user interface

InstantAccess bar™

► **InstantAccess bar™ for quick access to your frequently used functions**

InstantAccess bar™ contains shortcut menus for frequently used functions and actions, allowing for quick access to essential tasks.

Radar function menu

- TX STBY
- PULSE S2
- TUNE AUTO
- IR 1
- ES OFF
- EAV 1
- ACE OFF

Display setting menu

- MAP ON
- HL OFF
- CU/TM RESET
- OWN AIS
- AIS
- PLT1
- 100

► **Well-designed controllers for stress-free operation**

Comfortable usability is very important on long voyages. With that in mind, these control units are designed based on ergonomics to comfortably accommodate the operator's hand. All operations can be controlled with the trackball.

EBL controls

User Customizable Function Keys

VRM controls

Control Unit

Menu Item Selector (wheel and enter keys)

Cursor Control

Trackball Control Unit



Refined antenna with excellent reliability and easy maintenance



The FAR-22x8 series is designed to provide clearer and more accurate Radar images of the surroundings, while increasing reliability and decreasing overall cost of ownership with easy maintenance.

Signals are safely transported through the Ethernet network between the antenna and below deck processing unit, allowing for higher reliability. High quality images are obtained by the signal processor inside the antenna unit, directly converting analog to digital signals before sending them to the main processor unit.

The new antenna's refined shape significantly reduces aerodynamic drag and lightens the burden on the gear box. The gear box itself has also been redesigned. Decreased aerodynamic drag and a DC brushless motor result in a very durable gear box that can be used for prolonged period of time.

Installation and maintenance are now easier than ever. All components of the gear box are integrated into one block that can easily be removed from the gear box when maintenance is required. The cable to the gear box can be connected from the side of the gear box.

Easy installation for new building as well as retrofits, with high flexibility

- ▶ Existing monitor, control unit and cables can be used in retrofitting*.

*Only when retrofitting in lieu of FAR-2xx7 series

- ▶ Optional LAN Signal Converter enables Ethernet communication. Extension of the cable between antenna unit and processor unit utilizing existing cables when retrofitting is possible.

- ▶ Ethernet connectivity enables interface and information exchange.

Ethernet expands the Radar's capability with connection between either existing or newly installed system, such as ECDIS and VDR.

- ▶ With the optional Ethernet HUB, Inter-switch can be utilized.

- ▶ DVI-I cable is connectible to VDR in retrofitting.

How to connect VDR with FAR-22x8 series

| | |
|--------------------------|--|
| VR-7000/7000S | Directly connect VDR with LAN or convert the RGB signal from a DVI-I port using video LAN converter, and input to the VDR. |
| VR-3000/3000S | Directly input the RGB signal from a DVI-I port to the VDR. |
| Other manufacturer's VDR | Please check with the VDR manufacturer to connect appropriately. |

Advanced technologies for safer and optimal navigation in all kinds of situations (option)

- ▶ **Wave Analyzer Software ***

- Allows real-time monitoring and analysis of wave echoes
- Ensures safety at sea even at night



*More details on the Wave Analyzer brochure

- ▶ **Ice Mode **** (X-band magnetron only)

- Find the best route through ice
- Observe ice conditions by Radar

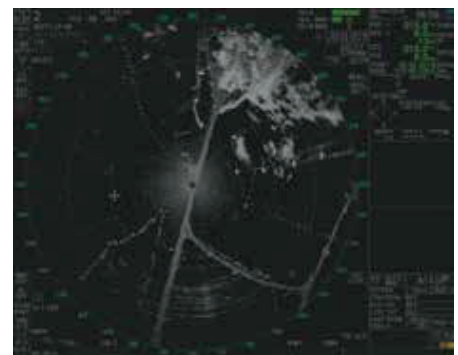

**Please contact your local distributor for more details

Product Name MARINE RADAR

Antenna Radiator

1. Type Slotted waveguide array

2. Beam width and sidelobe attenuation

| Radiator type | X-Band | | | S-Band |
|-----------------------|--------|--------|--------|--------|
| | XN12CF | XN20CF | XN24CF | SN36CF |
| Length | 4 ft | 6.5 ft | 8 ft | 12 ft |
| Horizontal beam width | 1.9° | 1.23° | 0.95° | 1.8° |
| Vertical beam width | 20° | 20° | 20° | 25° |
| Sidelobe within ±10° | -24 dB | -28 dB | -28 dB | -24 dB |
| Sidelobe outside ±10° | -30 dB | -32 dB | -32 dB | -30 dB |

3. Polarization Horizontal

4. Rotation 24 rpm or 42 rpm (for high speed craft)

*XN24CF not available in 42 rpm

5. Wind load 100 kn relative

6. De-icer (option)

On: when temperature goes down to 0°C

Off: when temperature goes up to +5°C

Transceiver

1. TX Frequency and modulation

| | |
|----------------------|---|
| X-band (Magnetron) | 9410 MHz ±30 MHz, P0N |
| S-band (Magnetron) | 3050 MHz ±30 MHz, P0N |
| X-band (Solid state) | CH1 P0N: 9403.75 MHz/Q0N: 9423.75 ±5MHz or CH2 P0N: 9413.75 MHz/Q0N: 9433.75 ±5MHz |
| S-band (Solid state) | CH1 P0N: 3043.75 MHz/ Q0N: 3063.75 MHz ±5 MHz or CH2 P0N: 3053.75 MHz/ Q0N: 3073.75 MHz ±5 MHz |

2. Output power

| | |
|----------------------------|-------|
| FAR-2218/2218-BB | 12 kW |
| FAR-2228/2228-BB | 25 kW |
| FAR-2228-NXT/2228-NXT-BB | 600 W |
| FAR-2238S/2238S-BB | 30 kW |
| FAR-2238S-NXT/2238S-NXT-BB | 250 W |

3. Range scale, Pulse Repetition Rate and Pulselength

Magnetron radar: FAR-2218/2218-BB/2228/2228-BB/2238S/2238S-BB

| PRR (Hz approx.) | Range scale (NM) | | | | | | | | | | |
|---------------------|------------------|------|-----|------|-----|---|---|----|----|----|----|
| | 0.125 | 0.25 | 0.5 | 0.75 | 1.5 | 3 | 6 | 12 | 24 | 48 | 96 |
| 3000 | S1 | | | | | | | | | | |
| 3000 | S2 | | | | | | | | | | |
| 1500 | | | | | M1 | | | | | | |
| 1200 | | | | M2 | | | | | | | |
| 1000 | | | M3 | | | | | | | | |
| 600* | | | | | L | | | | | | |

*: 500 Hz on 96 NM range.

Solid state radar: FAR-2228-NXT/2228-NXT-BB

| PRR (Hz approx.) | Range scale (NM) | | | | | | | | | | |
|---------------------|------------------|------|-----|------|-----|---|---|----|----|----|----|
| | 0.125 | 0.25 | 0.5 | 0.75 | 1.5 | 3 | 6 | 12 | 24 | 48 | 96 |
| 1500 | S1 | | | | | | | | | | |
| 1500 | S2 | | | | | | | | | | |
| 1200 | | | | | M1 | | | | | | |
| 1000 | | | | M2 | | | | | | | |
| 1000 | | | M3 | | | | | | | | |
| 600 | | | | | L | | | | | | |

Solid state radar: FAR-2238S-NXT/2238S-NXT-BB

| PRR (Hz approx.) | Range scale (NM) | | | | | | | | | | |
|---------------------|------------------|------|-----|------|-----|---|---|----|----|----|----|
| | 0.125 | 0.25 | 0.5 | 0.75 | 1.5 | 3 | 6 | 12 | 24 | 48 | 96 |
| 2400 | S1 | | | | | | | | | | |
| 2000 | S2 | | | | | | | | | | |
| 1500 | | | | | M1 | | | | | | |
| 1060 | | | | M2 | | | | | | | |
| 1000 | | | M3 | | | | | | | | |
| 600 | | | | | L | | | | | | |

Processor Unit

1. Minimum range 22 m

2. Range discrimination 26 m

3. Range accuracy

1% of the maximum range of the scale in use or 10 m, whichever is the greater

4. Bearing discrimination

2.1° (XN12CF), 1.5° (XN20CF), 1.2° (XN24CF), 2.0° (SN36CF)

5. Bearing accuracy ±1°

6. Range scale and Range ring interval (RI)

| Range (NM) | 0.125 | 0.25 | 0.5 | 0.75 | 1.5 | 3 | 6 | 12 | 24 | 48 | 96 |
|-----------------|-------|------|-----|------|------|-----|---|----|----|----|----|
| RI (NM) | 0.025 | 0.05 | 0.1 | 0.25 | 0.25 | 0.5 | 1 | 2 | 4 | 8 | 16 |
| Number of rings | 5 | 5 | 5 | 3 | 6 | 6 | 6 | 6 | 6 | 6 | 6 |

7. Warm-up time

3 min. approx. (solid state radar excluded)

8. Presentation mode

Head-up, STAB head-up, Course-up, North-up (RM/TM), Stern-up

9. Marks

Cursor, Range ring, Heading mark, North mark, Bearing mark, Target trail, VRM, EBL, Acquisition zone

10. Target tracking (TT)

Auto or manual acquisition 100 targets in 24/32 NM (range selected from setting menu)

Tracking 5/10 pts on all targets

Vector time Off, 30 s, 1-60 min

11. AIS

Display capacity 350 targets

Tracking 5/10 pts on activated targets

Vector time Off, 30 s, 1-60 min

12. Radar map 20,000 points

13. Acquisition zone 2 zones

14. Interswitch function Selectable from menu

Display Unit

MU-190

| | |
|-----------------------------|---------------------------------------|
| 1. Screen type | 19-inch color LCD, 1280 x 1024 (SXGA) |
| 2. Brightness | 450 cd/m ² typical |
| 3. Visible distance | 1.02 m nominal |
| 4. Radar effective diameter | 282 mm |

Interface

1. Number of port (processor unit)

| | |
|-------------------------|---|
| Serial | 7 ports (IEC61162-1/2: 2 ports, IEC61162-1: 4 ports, AD-10: 1 port) |
| Alarm output | 6 ports: contact signal, load current 250 mA (Normal close/ open: 4, System fail: 1, Power fail: 1) |
| DVI output | 2 ports: DVI-D, DVI-I or RGB picture data (VDR) |
| LAN | 2 ports: Ethernet 100Base-TX |
| RS-232C | 1 port: brilliance control |
| Sub display (for ECDIS) | 2 ports: HD, BP, Trigger and Video signal |

2. Data sentences (IEC61162-1/2, IEC61162-450)

| | |
|--------|---|
| Input | ABK, ACK, ACN, ALR, BWC, BWR, CUR, DBK*, DBS*, DBT, DDC, DPT, DTM, GGA, GLL, GNS, HBT, HDT*, MTW, MWV, OSD, RAQ, RMB, RMC, ROT, RTE, THS, VBW, VDM, VDO, VDR, VHW, VSD, VTG, VWR*, VWT*, WPL, ZDA |
| Output | ABM, ACK, AIQ, ALC, ALF, ALR, ARC, BBM, DDC, EVE, HBT, OSD, RSD, TLB, TLL, TTD, TTM, VSD |

*1: for retrofit.

3. Ethernet interface for IEC61162-450

| | |
|--|--|
| Port (LAN2) | 100Base-TX, IPv4, 8P8C connector |
| IEC61162-450 transmission group | |
| Input | MISC, TGTD, SATD, NAVD, TIME, PROP |
| Output | Arbitrary (default: TGTD) |
| Multicast address | 239.192.0.1 to 239.192.0.16 |
| Destination port | 60001 to 60016 |
| Re-transmittable binary image transfer | |
| Multicast address | 239.192.0.26 to 239.192.0.30 |
| Destination port | 60026 to 60030 |
| Other network function excepted IEC61162-450 | |
| | SNMP, HTTP, Syslog, Furuno Management Protocol (FMP) |

4. Output port on antenna unit

Sub display (for radar) 1 port: HD, BP, Trigger and Video signal

Power Supply

1. Processor unit

| | |
|---------------------|---|
| FAR-2218 | 100-230 VAC: 2.1-1.0 (2.9-1.3)A, 1 phase, 50-60 Hz / 24VDC (21.6-31.2V): 5.4 (9.0)A* |
| FAR-2228 | 100-230 VAC: 2.3-1.1 (3.2-1.4)A, 1 phase, 50-60 Hz / 24VDC (21.6-31.2V): 8.9 (12.4)A* |
| FAR-2228-NXT (-BB) | 100-230 VAC: 2.1-1.0 (2.9-1.3)A, 1 phase, 50-60 Hz / 24VDC (21.6-31.2V): 8.2 (11.1)A* |
| FAR-2238S | 100-230 VAC: 3.2-1.5 (5.6-2.5)A, 1 phase, 50-60 Hz |
| FAR-2238S-NXT (-BB) | 100-230 VAC: 2.6-1.2 (5.1-2.2)A, 1 phase, 50-60 Hz |

(): 42 rpm

*Specify when ordering

2. Display Unit

100-230 VAC: 0.7-0.4 A, 1 phase, 50-60 Hz

3. HUB (option)

100-230 VAC: 0.1 A max. 1 phase, 50/60 Hz

4. De-icer (option)

100-115/220-230 VAC: 2.6/1.3 A, 1 phase, 50-60 Hz

Environmental Conditions

1. Ambient temperature

| | |
|--------------|--|
| Antenna unit | -25°C to +55°C (storage: -25°C to +70°C) |
| Indoor units | -15°C to +55°C (storage: -20°C to +70°C) |

2. Relative humidity

95% or less at +40°C

3. Degree of protection

| | |
|-------------------------|---------------------------------|
| Antenna unit | IP56 |
| Processor/ monitor unit | IP22 |
| Control unit | IP20 |
| HUB | IP20 (HUB-100), IP22 (HUB-3000) |

4. Vibration

IEC 60945 Ed.4

Equipment List

Standard

- Display Unit MU-190
- Processor Unit RPU-025
- Control Unit RCU-014
Trackball Control Unit (Specify when ordering) RCU-015
- Antenna Radiator XN12CF/XN20CF/XN24CF/SN36CF
- Transceiver RTR-105/106/107/111
- Gear Box RSB-128/129/133
- DVI cable (5 m) DVI-D/D S-LINK 5M, not supplied with BB model
- Standard Spare Parts and Installation Materials
- Performance Monitor PM-32A/52A/52B

Option

- Remote Control Unit RCU-016
- Junction Box RJB-001
- AD Converter AD-100-E
- Switching HUB HUB-100
- Intelligent HUB HUB-3000
- De-icer OP03-226/227/231/232
- LAN Signal Converter
X-band (magnetron) OP03-247-3, X-band (NXT) OP03-247-4,
S-band (magnetron) OP03-247-2, S-band (NXT) OP03-247-1
- Wave Analyzer Software WV-100/WV-100ST

INTERCONNECTION DIAGRAM

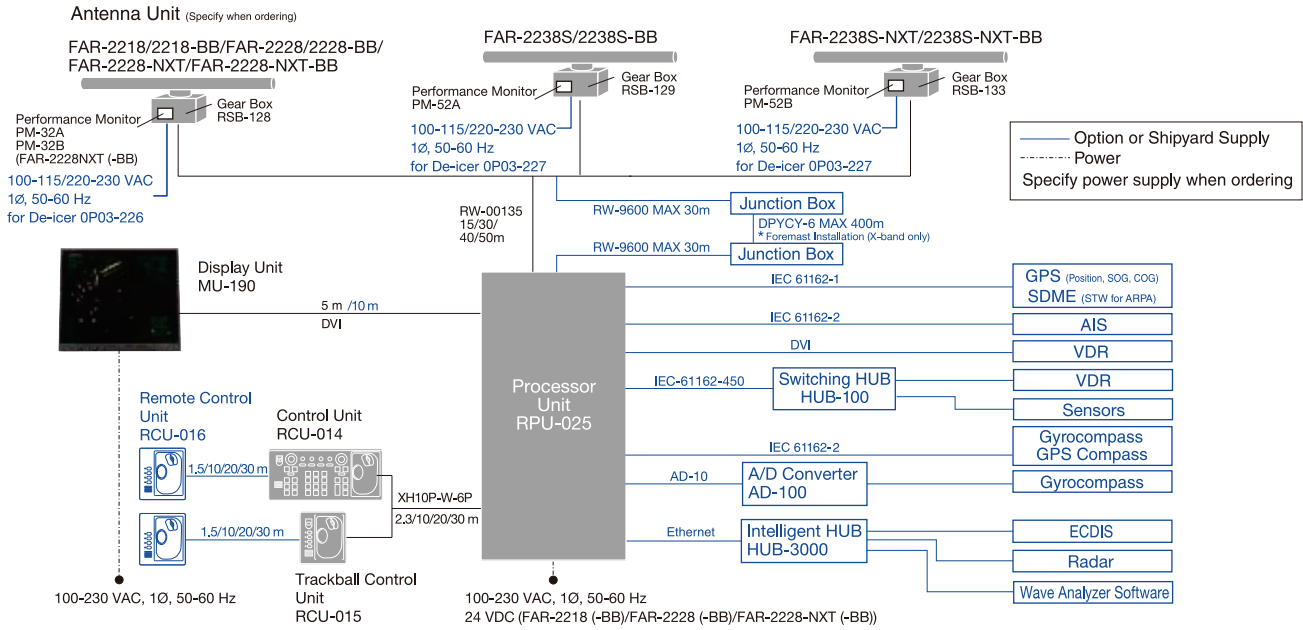

Processor Unit RPU-025

X-band/ S-band 24rpm w/ Fan 9.6 kg 21 lb
 S-band 42rpm w/ 2 Fan 11.5 kg 25 lb

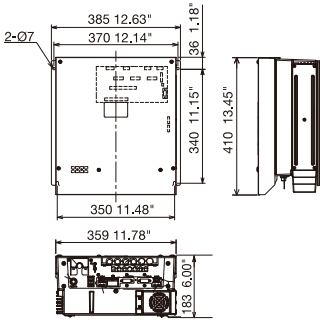

Control Unit RCU-014

2.5 kg 5.5 lb

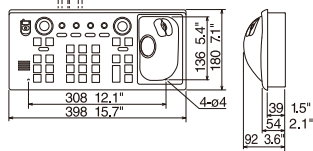

Trackball Control Unit RCU-015

2.4 kg 5.3 lb

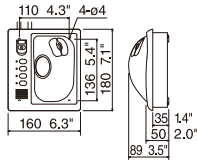

Remote Control Unit RCU-016

2.4 kg 5.3 lb

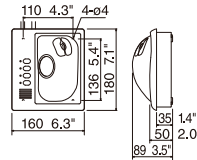

Display Unit MU-190

8.8 kg 19.4 lb

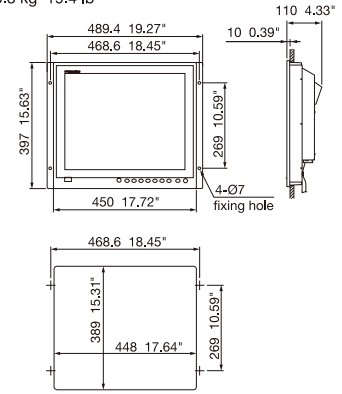

Antenna Unit for FAR-2218/2218-BB/2228/2228-BB/2228-NXT/2228-NXT-BB

Radiator XN12CF 46.2 kg 101.9 lb
XN20CF 48.1 kg 106.1 lb
XN24CF 49.3 kg 108.7 lb

XN12CF: 1297 51.1"
 XN20CF: 2097 82.6"
 XN24CF: 2597 102.2"

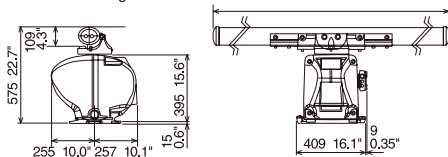

Antenna Unit for FAR-2238S/2238S-BB/2238S-NXT/2238S-NXT-BB

Radiator SN36CF 144 kg 317.5 lb

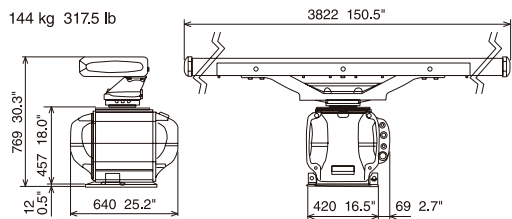

Beware of similar products

All brand and product names are registered trademarks, trademarks or service marks of their respective holders.

SPECIFICATIONS SUBJECT TO CHANGE WITHOUT NOTICE

FURUNO ELECTRIC CO., LTD.
 Japan | www.furuno.com

FURUNO U.S.A., INC.
 U.S.A. | www.furunousa.com

FURUNO PANAMA S.A.
 Republic of Panama | www.furuno.com.pa

FURUNO (UK) LIMITED
 U.K. | www.furuno.co.uk

FURUNO NORGE A/S
 Norway | www.furuno.no

FURUNO DANMARK A/S
 Denmark | www.furuno.dk

FURUNO SVERIGE AB
 Sweden | www.furuno.se

FURUNO FINLAND OY
 Finland | www.furuno.fi

FURUNO POLSKA Sp. z o.o.
 Poland | www.furuno.pl

FURUNO DEUTSCHLAND GmbH
 Germany | www.furuno.de

FURUNO FRANCE S.A.S.
 France | www.furuno.fr

FURUNO ESPAÑA S.A.
 Spain | www.furuno.es

FURUNO ITALIA S.R.L.
 Italy | www.furuno.it

FURUNO HELLAS S.A.
 Greece | www.furuno.gr

FURUNO (CYPRUS) LTD
 Cyprus | www.furuno.com.cy

FURUNO EURUS LLC
 Russian Federation | www.furuno.ru

FURUNO SHANGHAI CO., LTD.
 China | www.furuno.com/cn

FURUNO CHINA CO., LTD.
 Hong Kong | www.furuno.com/cn

FURUNO KOREA CO., LTD
 Korea

FURUNO SINGAPORE
 Singapore | www.furuno.sg

PT FURUNO ELECTRIC INDONESIA
 Indonesia | www.furuno.id

FURUNO ELECTRIC (MALAYSIA) SND. BHD.
 Malaysia | www.furuno.my